

- **Designed for 345 MHz Wireless Applications**
- **Advanced (Lithium Tantalate) LiTaO<sub>3</sub> design for low Insertion Loss**
- **Designed for match to 50 ohms, no external LC required**
- **Hermetically sealed Surface Mount package**
- **Complies with Directive 2002/95/EC (RoHS)**

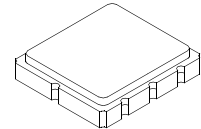

**RF1353C**

**345.00 MHz  
SAW Filter**



**SM5050-8 Case**

**Absolute Maximum Ratings**

Rating	Value	Units
Maximum Input Power	+10	dBm
Maximum DC Voltage Between Terminals	30	VDC
Case Temperature	-40 to +85	°C

Characteristic	Sym	Notes	Minimum	Typical	Maximum	Units
Nominal Operating Frequency	$f_C$			345		MHz
Passband	Insertion Loss				4.5	dB
	3.0 dB Bandwidth		$f_C \pm 70$	$f_C \pm 430$	$f_C \pm 1100$	kHz
Rejection	$f_C - 10.7$ MHz		15			dB
	$f_C - 21.4$ MHz		40			dB
Matching	Untuned response			50		$\Omega$
Ambient Temperature	Operating Range		-10		70	°C
Footprint: 5.0 X 5.0 mm						SM5050-8
Lid Symbolization (YY=Year, WW=week, S=shift)						446, <u>Y</u> WWS

**Electrical Connections**

Connection	Terminals
RF Input	2
RFOutput	6
Case Ground	All Others



**CAUTION: Electrostatic Sensitive Device. Observe precautions for handling.**

**NOTES:**

1. All specifications apply over the operating temperature range with filter soldered to the specified demonstration board unless noted otherwise.
2. Ultimate rejection is dependent on PCB layout.
3. Specifications subject to change without notice.
4. Electrostatic Sensitive Device. Observe precautions for handling.
5. US and international patents may apply.
6. Murata, stylized Murata logo, and Murata N.A., Inc. are registered trademarks of Murata Manufacturing Co., Ltd.

# SM5050-8 Case

## 8-Terminal Ceramic Surface-Mount Case

### 5.0 X 5.0 mm Nominal Footprint

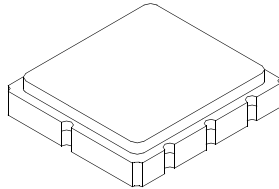

#### Case Dimensions

Dimension	mm			Inches		
	Min	Nom	Max	Min	Nom	Max
A	4.8	5.0	5.2		0.1968	
B	4.8	5.0	5.2		0.1968	
C			1.7			0.0669
D		2.08			0.0818	
E		1.17			0.046	
F		0.64			0.0252	
G	2.39	2.54	2.69		0.100	

#### Electrical Connections

Connection		Terminals
Port 1	Differential Input	1, 2
Port 2	Differential Output	5, 6
	Ground	All others
Single-ended Operation		Return is ground
Differential Operation		Return is hot
Dot indicates Pin 1		

#### TOP VIEW

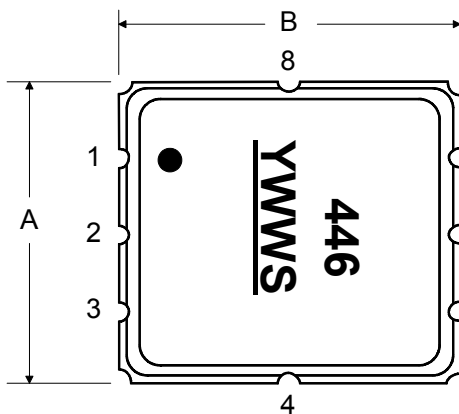

#### BOTTOM VIEW

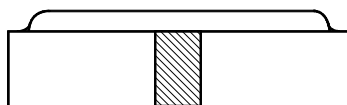
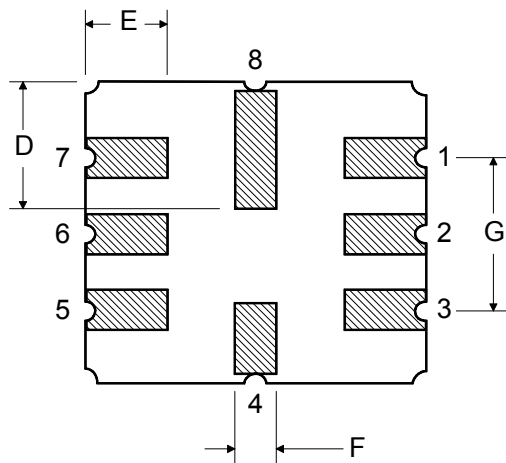

## Tape and Reel Specifications

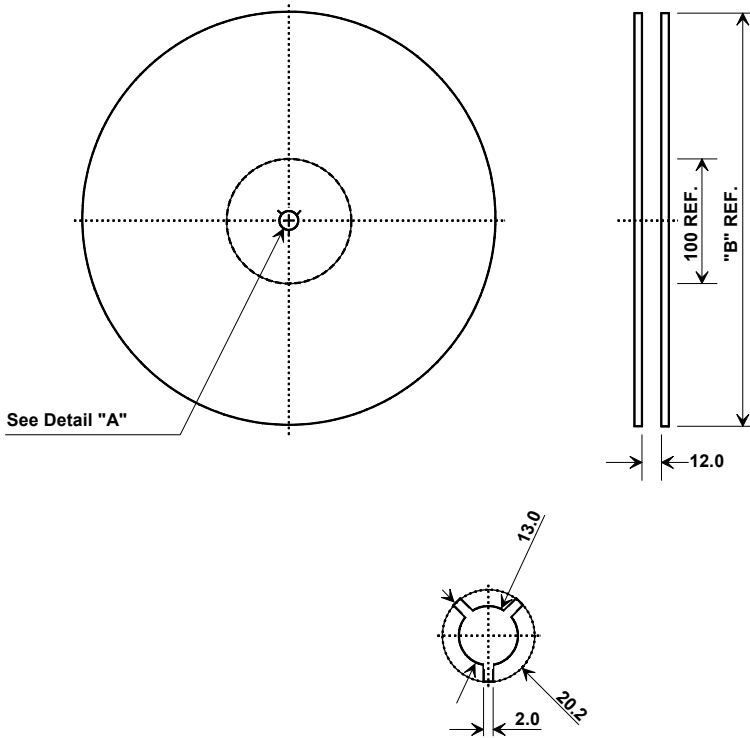

"B" Nominal Size		Quantity Per Reel
Inches	millimeters	
7	178	500
13	330	3000

## COMPONENT ORIENTATION and DIMENSIONS

Carrier Tape Dimensions	
<b>A<sub>o</sub></b>	5.3 mm
<b>B<sub>o</sub></b>	5.3 mm
<b>K<sub>o</sub></b>	2.0 mm
<b>Pitch</b>	8.0 mm
<b>W</b>	12.0 mm

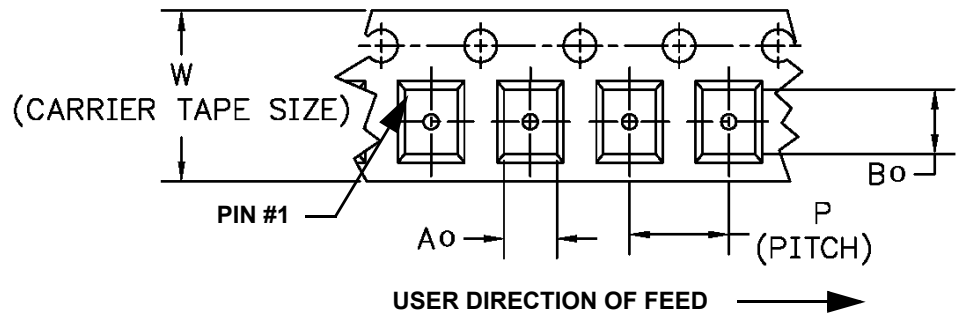
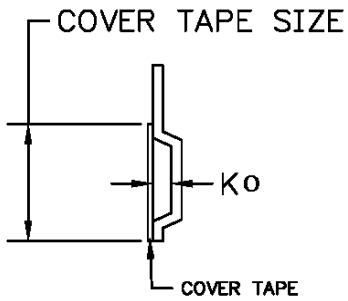

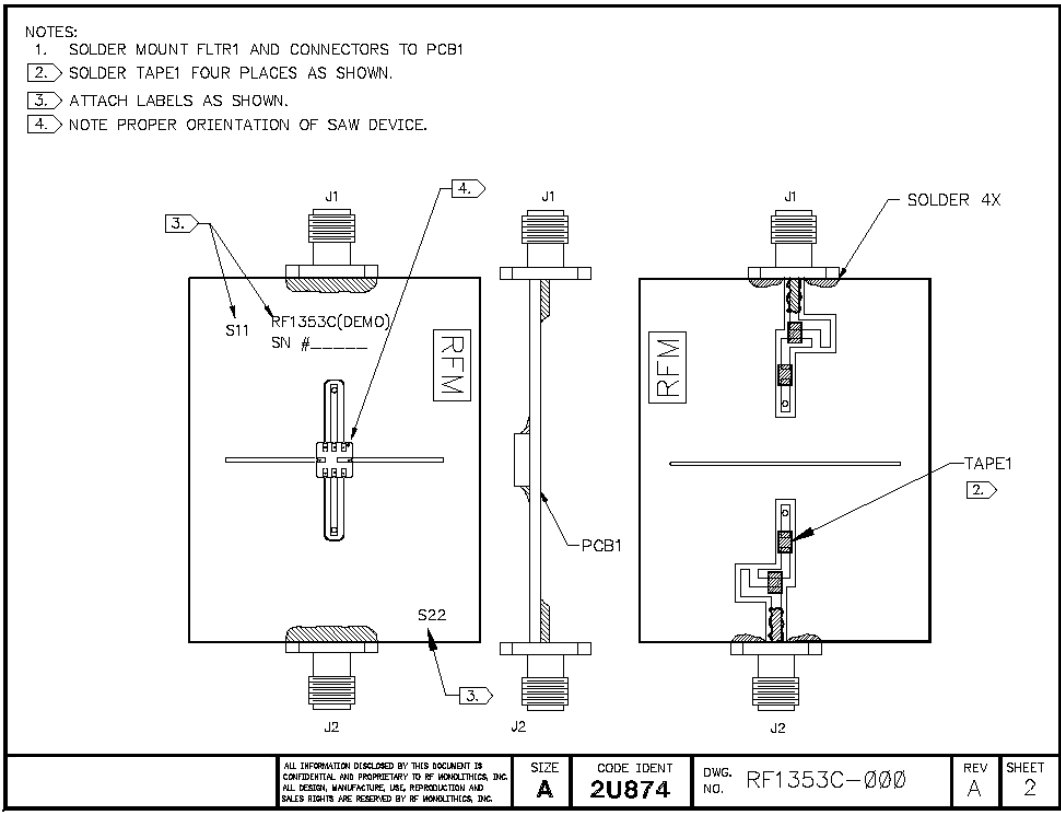
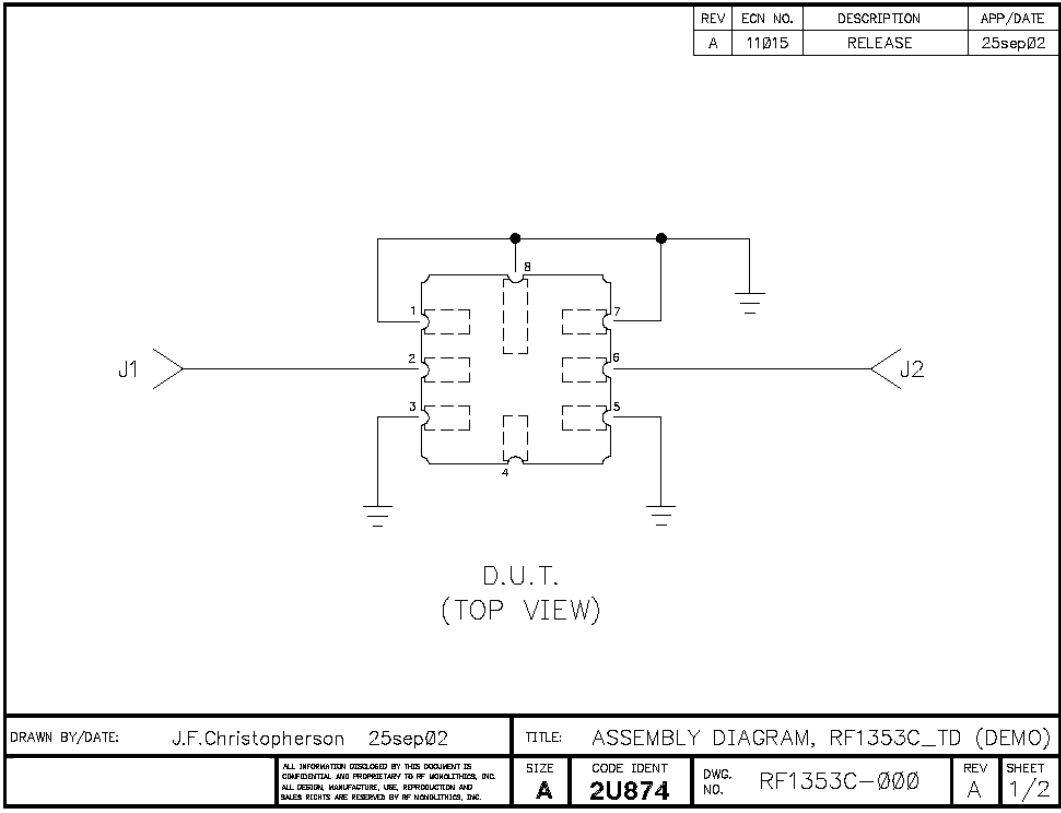

22 May 2002 13:01:48  
 CH1 S21 log MAG 1 dB/ REF -4.2 dB 1 0 dB

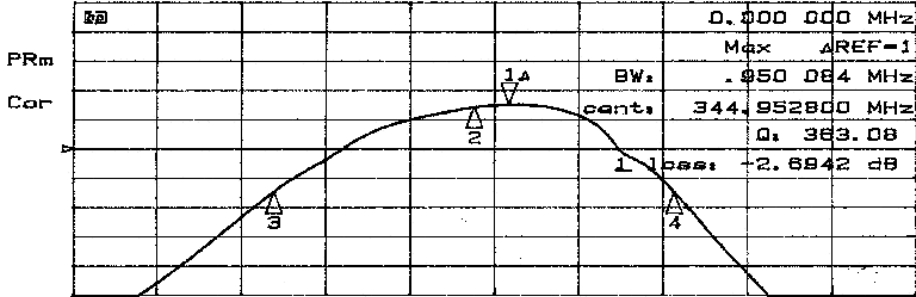

CH1 CENTER 345.000 000 MHz SPAN 2.000 000 MHz  
 CH2 S21 log MAG 10 dB/ REF -2.973 dB 1 0 dB

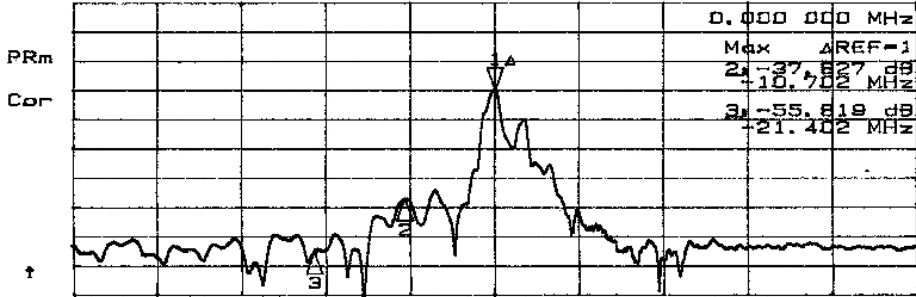

CH2 CENTER 345.000 000 MHz SPAN 100.000 000 MHz

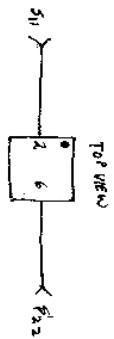

22 May 2002 13:06:59  
 CH1 S11 1 U FS 1 45.432 n 4.3457 n 2.0048 nH  
 345.000 000 MHz

PRm  
 Cor

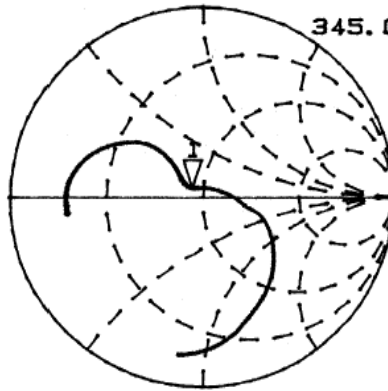

CH2 S22 1 U FS 1 46.686 n 2.0625 n 951.47 pF  
 345.000 000 MHz

PRm  
 Cor

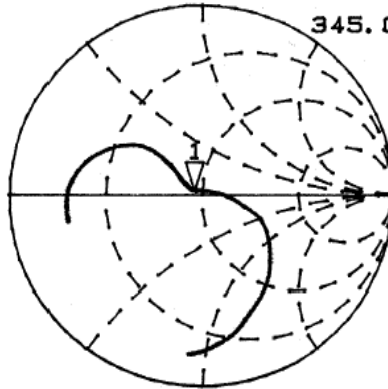

CENTER 345.000 000 MHz SPAN 2.000 000 MHz